

Astro - Physics

2703 Hampden Ct.
Rockford, Illinois 61107
Phone (815) 226-1471

Dear Steve,

Enclosed is a current catalog of our telescopes. Due to a 6 month backlog in orders, we are not accepting any new orders at this time.

By the way, have you heard of the Rockford Amateur Astronomers? We are building a 10 inch refractor for our observatory at the Children's farm. It should be done sometime this spring, in time for the Mars spectacular.

If you want to know more about our activities, contact Mike Caldwell at 602 Barnum Road

Rockford 61109

Tel 397-6761

Sincerely, Ruschert

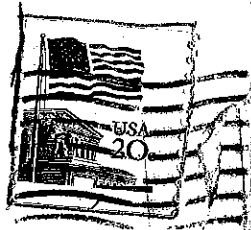

1
8

Astro - Physics

2703 Hampden Ct.
Rockford, Illinois 61107

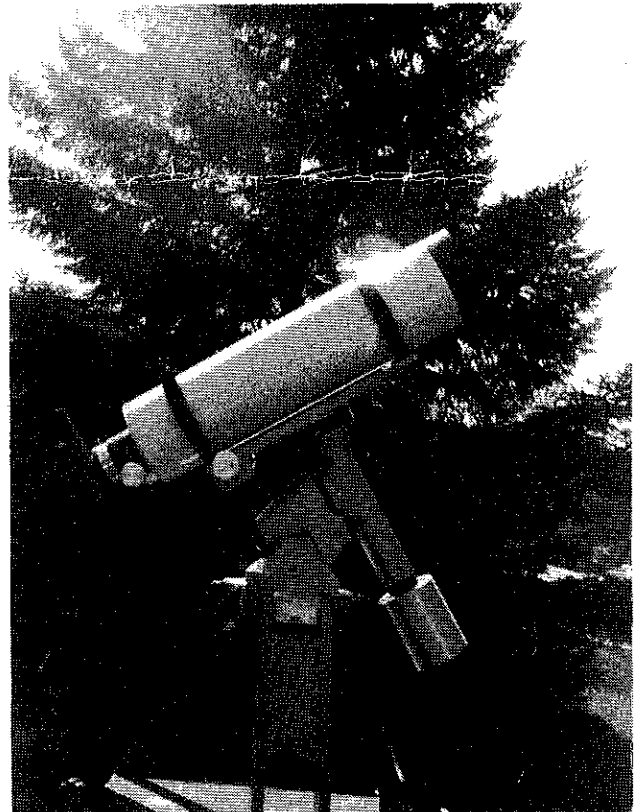
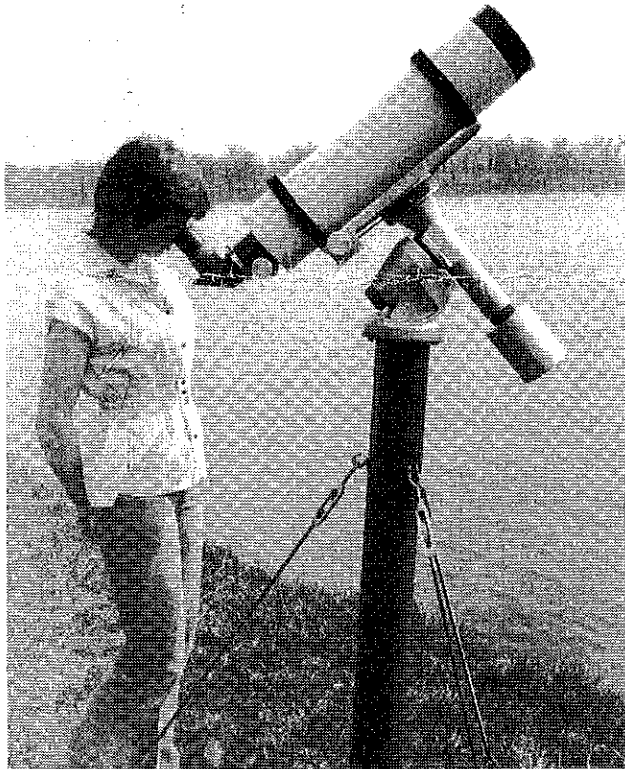

We are proud to offer to you a precision telescope system based on the award winning CHRISTEN TRIPLET design. These telescopes and their accessories were developed using advanced engineering techniques, and were thoroughly tested under actual observing conditions. Only the finest materials are used in their construction. We offer a full ONE YEAR WARRANTY on our products. We will repair or replace any items that fail due to defects in materials or workmanship. A full refund is allowed on all items that are returned in good condition within 60 days of purchase for any reason.

TRIPLET APOCHROMAT REFRACTORS

The three matched optical glasses in our objectives combine the colors of the visual spectrum into bright, sharp, concentrated images, with superior contrast and light gathering power. We use only the highest quality glass that is free of striae and imperfection to obtain unparalleled resolution for this size range.

The lack of secondary obstruction results in a clean optical system with superb performance for lunar/planetary observations. All our lenses are polished on pitch and hand corrected on a double pass interferometer. The surfaces are smooth and free of zones out to the extreme edges. Planetary detail is crisp even at the highest power. Double stars are split cleanly up to the theoretical limits.

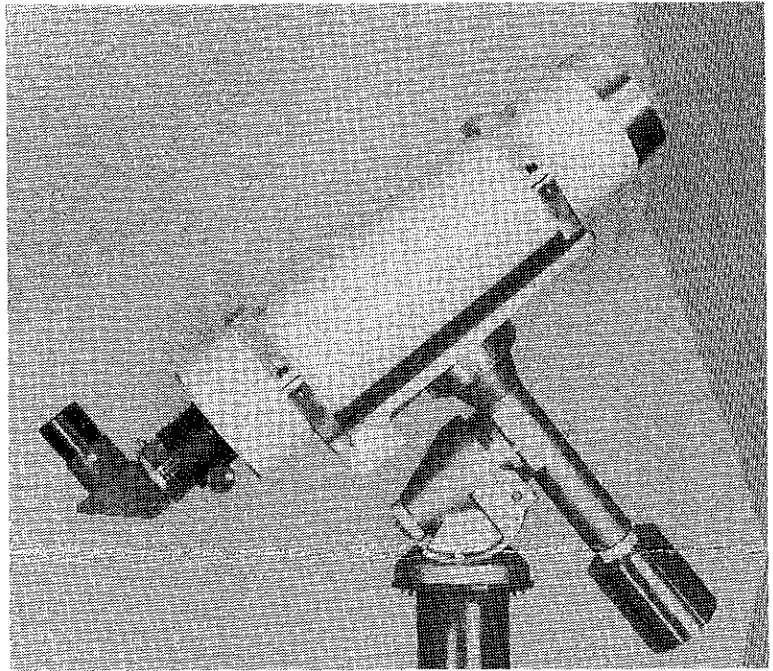

5 INCH F6 PHOTO-VISUAL ASTROCAMERA

This optical system was designed specially for wide field astrophotography. At F6 it is fast enough to capture deep sky objects in 10 to 30 minutes, yet with long exposures can record stars to 18th magnitude before sky fog limits are reached. We have captured the faint outer ring of M42 in only 30 minutes on ASA 400 Ektachrome, without resorting to hypering or cold camera techniques. Yet the original slide still shows the four stars of the Trapezium, as well as the inner nebular detail. This is a testimonial to the remarkable contrast range of this highly corrected design.

5 INCH F12 DEEP SKY / PLANETARY REFRACTOR

Designed for visual use, the lens in this refractor is corrected for the yellow-green visual peak. Correction extends from C to F wavelengths, with all the colors in between focusing at the same point. Essentially no color is seen on even the brightest objects. Low power sweeping with 2 inch oculars shows deep sky objects in high contrast against velvet black skies. The inherent nature of a refractor's clean optical surfaces and fully baffled tube keeps scattered light to an absolute minimum. Powers up to 500X are feasible for lunar/planetary or double star work. Saturn's Cassini division and the Crepe ring are bold and crisp. Half a dozen craterlets are seen on Plato's floor. The Alpine valley appears as a flat, wide river with tiny craters embedded in it's sheer walls. Solar granulation can be seen even in poor atmospheric conditions due to the high contrast of this lens.

PRICES

5 INCH F6 OPTICAL TUBE ASSEMBLY, with giant focuser and eyepiece adapters	950.00
5 INCH F12 OPTICAL TUBE ASSEMBLY, with giant focuser and eyepiece adapters	975.00
MAGNESIUM FLUORIDE COATINGS, on all air-glass surfaces, add	75.00
MATCHING DEWCAP, slides over objective cell	29.00
8X50 FINDERSCOPE, with mounting rings	65.00
SOLAR FILTER, aluminized mylar type, mounted in matching cell	55.00
2 INCH TELECOMPRESSOR FOR F4 PHOTOGRAPHY, covers 35mm format	78.00
35mm CAMERA ADAPTER, state your camera model	35.00

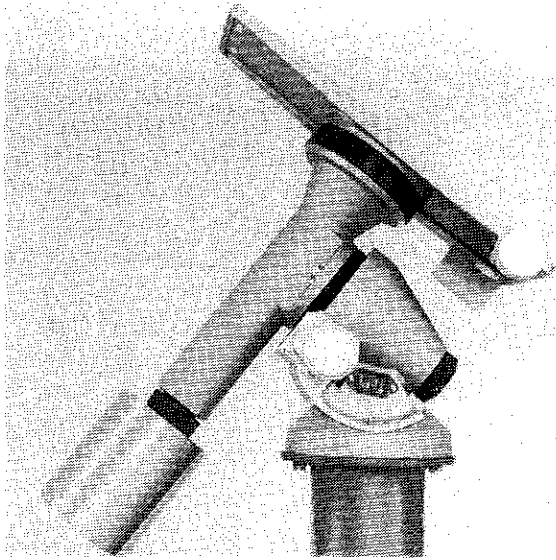

5 INCH EQUATORIAL MOUNT

A good mounting is equally as important as the optics in a telescope system. Our mounting features thrust bearing surfaces to transfer the telescope's mass to the tripod, thereby achieving maximum rigidity at minimum weight. Designed for astrophotography and high power work, this mount is steady even in gusting winds. Stainless ball bearings are used throughout, and solid stainless shafts guide the R.A. and Dec. axes. The declination features a precision tangent arm slow motion adjustment. The R.A. axis is driven by a synchronous motor and bronze worm for error free tracking. Both axes respond to fingertip pressure with no hint of backlash. Built in clutches can be disengaged for ultra-smooth sweeping, or locked for astrophotography and high power visual observations.

The entire mount disassembles quickly for easy transport and storage.

ELECTRIC DECLINATION DRIVE

A must for astrophotography, this accessory attaches quickly into pre-drilled holes. It allows hands-off guiding in Dec. at a rate that produces error-free astrophotos. The 12 volt D.C. motor can be operated from battery power or from our Dual Axis Drive Corrector. The timing belt drive provides instant reversing response, and the built in slip clutch allows manual adjustment simultaneously.

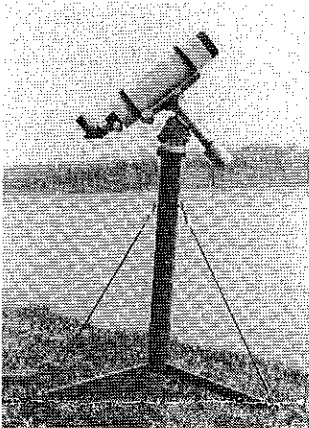
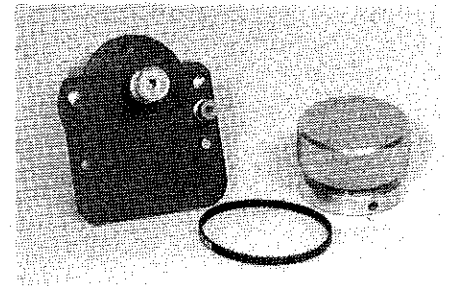

PORTABLE PIER MOUNT

This pier mounting features a unique tension design that combines rugged construction and light weight while eliminating flexure and annoying vibrations. Legs attach without hardware, allowing field assembly in seconds. Tension rods are designed not to interfere when the telescope is pointed at the zenith. A 46" high model is available for the F6 system, and a 60" model is recommended for the F12 system.

SOLID OAK TRIPOD

This handsome tripod is built by American wood craftsmen from solid oak, yet it weighs only 30 lb. It features hand pegged construction, laminated bracing for high strength, and is finished in a beautiful protective lacquer. A sturdy shelf provides stiffness, and will hold all your observing accessories. The shelf removes easily with large hand knobs and the entire tripod collapses for transport and storage.

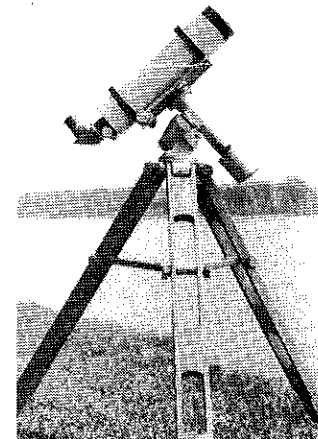

PRICES

5 INCH EQUATORIAL MOUNT, with counterweight	650.00
ELECTRIC DECLINATION DRIVE, with slip clutch and timing belt	58.00
PORTABLE PIER MOUNT, 46" model	275.00
PORTABLE PIER MOUNT, 60" model	285.00
SOLID OAK TRIPOD, with removable shelf	295.00

DUAL AXIS DRIVE CORRECTOR

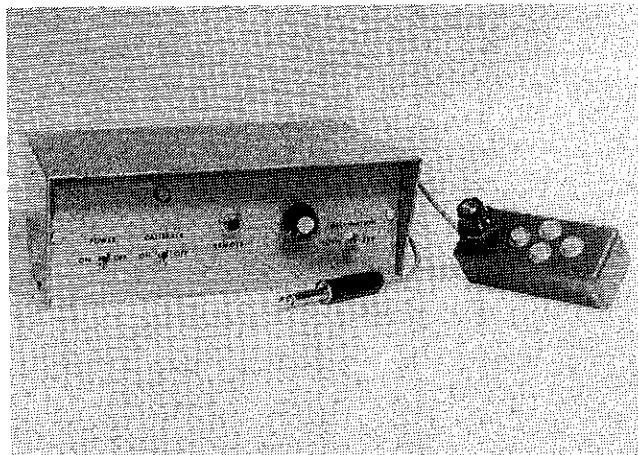

A must for astrophotography, this unit was specially designed for our equatorial mount. Input power can be either 12 volts DC or 115 volts AC house current. Advanced integrated circuit components stand up to temperature extremes from -50 F to 160 F. The fiber-glass printed circuit is treated with a moisture resistant coating which eliminates drift and erratic operation, even in heavy dewing conditions. The remote control features 4 push buttons for full R.A. and DEC. control. A fine adjust potentiometer is provided for trimming the R.A. frequency, and the front panel light can be used for exact calibration against the power line. The 24 watt output is enough to drive even the largest Amateur instrument, yet

this unit draws only 1/2 amp when operating our 5" equatorial from a 12 volt battery. The declination output is 12 volts DC for operating our Declination Drive. An AC declination output may also be ordered for driving 115 volt AC motors. All necessary cords are included.

GUIDING TELESCOPES

Our new guide scopes use the highest quality American made lenses for error free astrophotos. Both scopes show clean Airy discs without objectionable color aberrations. A built in barlow increases the effective focal length to 3000 mm. Overall length is kept to only 25 inches. Differential tube flexure is absent, assuring pinpoint star images on long exposures. The large mounting rings allow 5 degrees of motion for acquiring suitable guide stars, a real advantage over off-axis schemes.

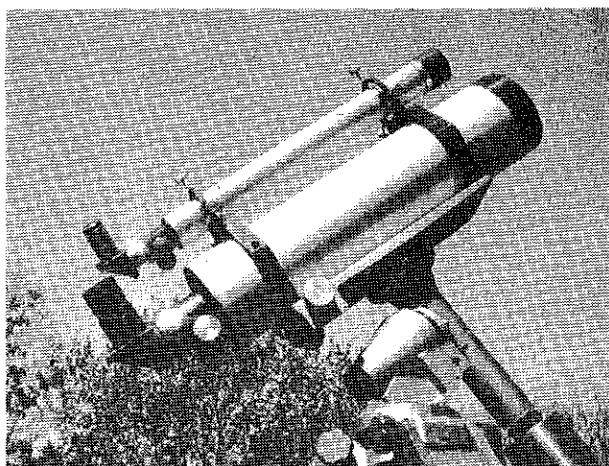

PRICES

DUAL AXIS DRIVE CORRECTOR, DC declination, 115VAC, 60HZ	175.00
AC DECLINATION OPTION, add	35.00
FOR FREQUENCIES AND VOLTAGES OTHER THAN ABOVE, add	22.00
2 INCH GUIDE SCOPE, with mounting rings	175.00
3 INCH GUIDE SCOPE, with mounting rings	275.00
ILLUMINATED RETICLE OCULAR ASSEMBLY, with battery pack	65.00
1 1/4 INCH PRISM DIAGONAL, magnesium fluoride coated	28.00

We also offer the complete line of TELEVUE OCULARS. Write for brochure and discounts.

ORDERING INFORMATION - When ordering by mail, be sure to include your complete street address. Illinois residents must include current state sales tax. Domestic orders are shipped U.P.S. Shipping charges will be collected C.O.D. Inspect packages carefully upon receipt and notify carrier of any damages.

METHOD OF PAYMENT - A check or money order included with your order is the best method. We no longer can accept C.O.D. CANADIAN orders must be paid in U.S. funds.

FOREIGN ORDERS - Payment in U.S. dollars by international money order, or a check drawn on a U.S. bank. Be sure to specify your voltage and frequency requirements.

DELIVERY TIMES - Delivery will vary from item to item. Please inquire for current delivery. Our telescopes use hand corrected optics, which take time to produce.

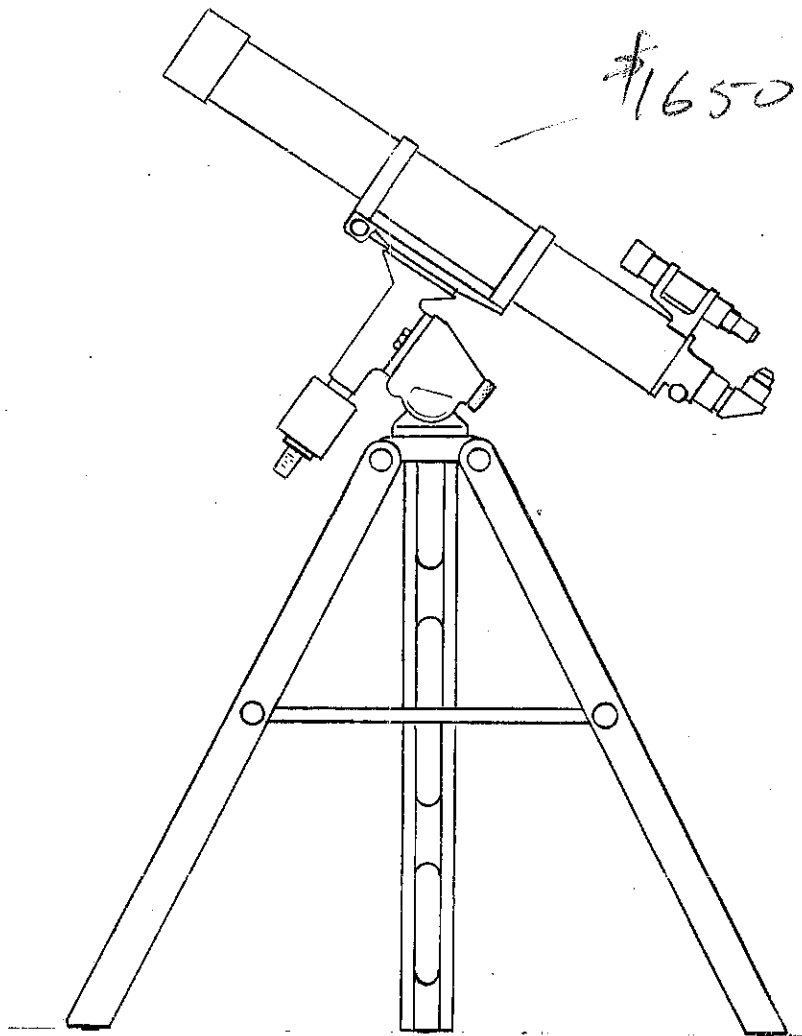

6 inch f/9 Triplet
Photo-visual Refractor